

No. _____

発電機
3 AC450V
50/60Hz
最大1000kW

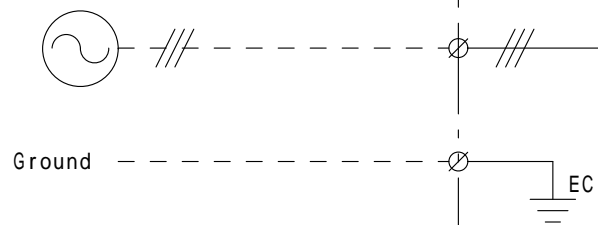

制御電源
AC200V 3 3W
50/60Hz 12kVA

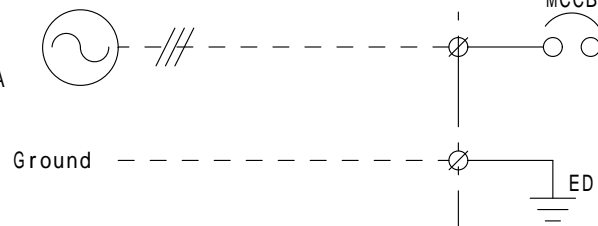

遠隔操作盤
(液晶タッチパネル)

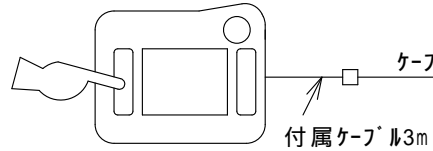

RESI-MASTER 1000L

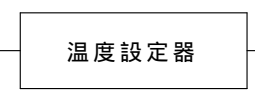
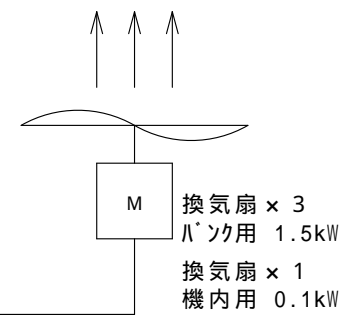
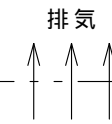
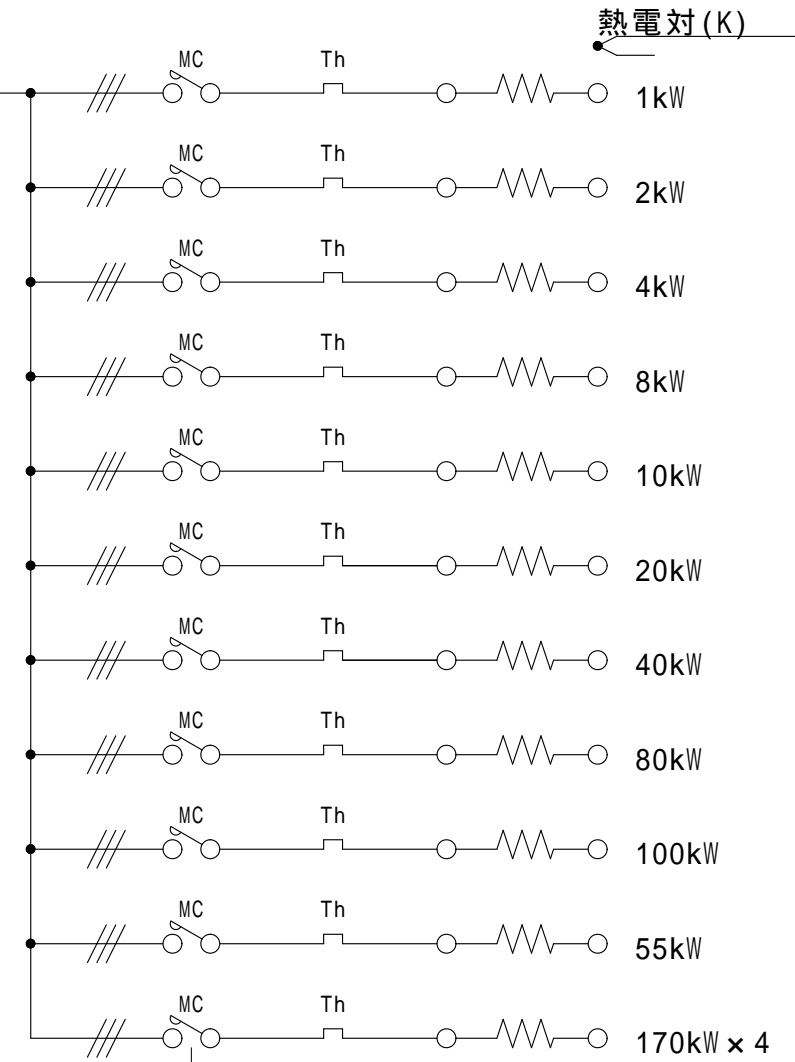
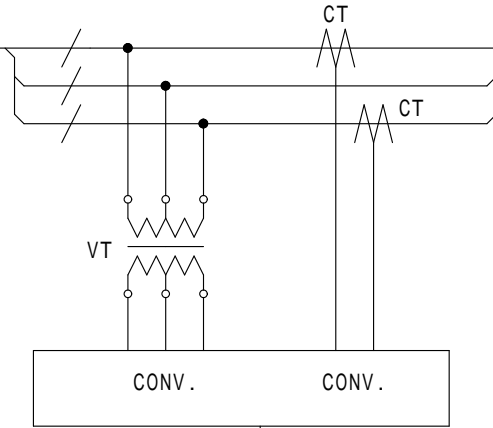

——— : 製作範囲内
- - - - : 製作範囲外

注！本図は製作時変更することがあります。

変
更

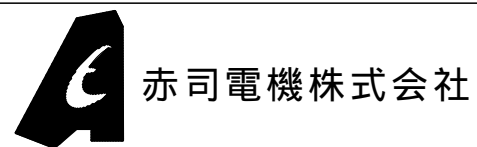

承認	照査	作成
間内	二宮	福島
'16.12.21	'16.11.17	'16.11.11

RESI-MASTER 1000L

システムブロック図

DRAWING NUMBER